

**CONTAMINATION CONTROL STUDY
ON
MINE DUST**

**by
Eric Kong
Student Assistant
Sudbury Neutrino Observatory Project
Lawrence Berkeley Laboratory
Berkeley, California
26 June, 1992**

SNO-STR-92-49

CONTAMINATION CONTROL STUDY ON MINE DUST

by
Eric Kong

Abstract

In order to ensure that the Sudbury Neutrino Observatory (SNO) is clean, some simple methods need to be developed for the cleanliness monitoring program. Two methods are selected and examined. The two methods, X-ray fluorescence and optical counting, can be used for detecting and quantifying the amount of mine dust on flat surfaces. X-ray fluorescence is based on element detection, a method that yields mine-dust mass measurement, whereas optical analysis is a particle counting technique that gives the number of mine-dust particles versus size. Samples with different amounts of mine dust are collected from the mine and/or generated with a modified glove-box at the lab by using tape-lift tests, wipe tests, and witness-plates. A standard procedure is developed, and the results of applying the two methods are summarized and presented in both tabular and graphical forms. According to the study results, X-ray fluorescence is better in mine dust mass detection than optical counting. Also, the mass/cm^2 correlates better with the number of particles/cm^2 having larger diameters. Finally, four sets of calibrated samples with mine dust level from 0.6 to 13.5 $\mu\text{g/cm}^2$ are made and will be used in the observatory's cleanliness program.

Table of Contents

	<u>Pages</u>
Abstract	i
1.0 Introduction	1-2
2.0 Experimental System	
2.1 Modified Glove-box	3
2.2 Wipe-test Device	4
2.3 X-ray Fluorescence	4-5
2.4 Optical Counting	5-6
3.0 Procedure and Methods	
3.1 Generating Samples	6-7
3.2 Sample Mounting	7-8
3.3 X-ray Fluorescence	8-9
3.4 Optical Counting	9-10
3.5 Combination	10-11
4.0 Results	11-21
5.0 Conclusion and Further Observations	21-22
6.0 Future Work	22
References	23

List of Figures

Figure

1. Surfaces and mine dust allowance in the observatory.	1
2. A flow diagram of this work.	2
3. A picture of the modified glove-box.	3
4. Schematic of the modified glove-box.	3
5. Preliminary wipe-test device.	4
6. Schematic of an X-ray fluorescence analysis system.	5
7. Picture of the microscope.	5
8. Microscope view for particle counting.	6
9. Typical clean bench showing the location of the HEPA filters and prefilters.	7
10. Mounting accessories and orientation.	7

11. A sample of an X-ray analysis result.	9
12. A typical optical counting result in graphical form.	10
13. Plot of number vs. size distribution for ground Norite samples.	13
14. Plot of samples with mine dust deposited on polypropylene foils mounted on leg and helmet during the underground tour on 6/91.	13
15. Plot of samples with mine dust deposited on polypropylene foils.	14
16. Plot of samples with mine dust deposited on air filters.	14
17. Mine dust (number-size distribution) on different surfaces measured by optical counting of tape lift and witness plates. (10/10/91)	16
18. Mine dust ($\mu\text{g}/\text{cm}^2$) on different surfaces measured by X-ray analysis of tape lift and witness plates. (10/10/91)	16
19. Mine dust (number-size distribution) on different surfaces measured by optical counting of tape lift and witness plates. (10/31/91)	18
20. Mine dust ($\mu\text{g}/\text{cm}^2$) on different surfaces measured by X-ray analysis of tape lift and witness plates. (10/31/91)	18
21. Comparison of total number of particles/ cm^2 with mass/ cm^2 (with dust particle diameter $D \geq 1\mu\text{m}$).	19
22. Comparison of total number of particles/ cm^2 with mass/ cm^2 (with dust particle diameter $D \geq 25\mu\text{m}$).	19

List of Tables

Table

1. Optical counting and X-ray fluorescence results of mine-dust samples collected by E.D. Hallman and R.G. Stokstad at the mine.	12
2. Optical counting and X-ray fluorescence results for the dust-blow experiment done on 10/10/91.	15
3. Optical counting and X-ray fluorescence results for the dust-blow experiment done on 10/31/91.	17
4. Recounting of selected Mylar-tape and polypropylene samples with X-ray fluorescence results.	20
5. Properties of the Mylar and Acrylic tapes.	21

CONTAMINATION CONTROL STUDY ON MINE DUST

1.0 Introduction

The cleanliness of the observatory has a major influence on the study of Neutrinos, especially for mine dust, which contains radio-active elements such as Uranium and Thorium. The area has to be maintained as clean as possible. However, dust cannot be eliminated completely but can be minimized at a certain level. Most of the dust will be generated during the construction and installation, including components being delivered to the mine. Therefore, we need to generate a standard method and procedure to monitor the dust level during fabrication above ground, installation below ground, and later on during operation. The $0.4 \mu\text{g}/\text{cm}^2$ dust level is the average maximum allowance on all surfaces in the observatory. This specification is detailed in Figure 1.

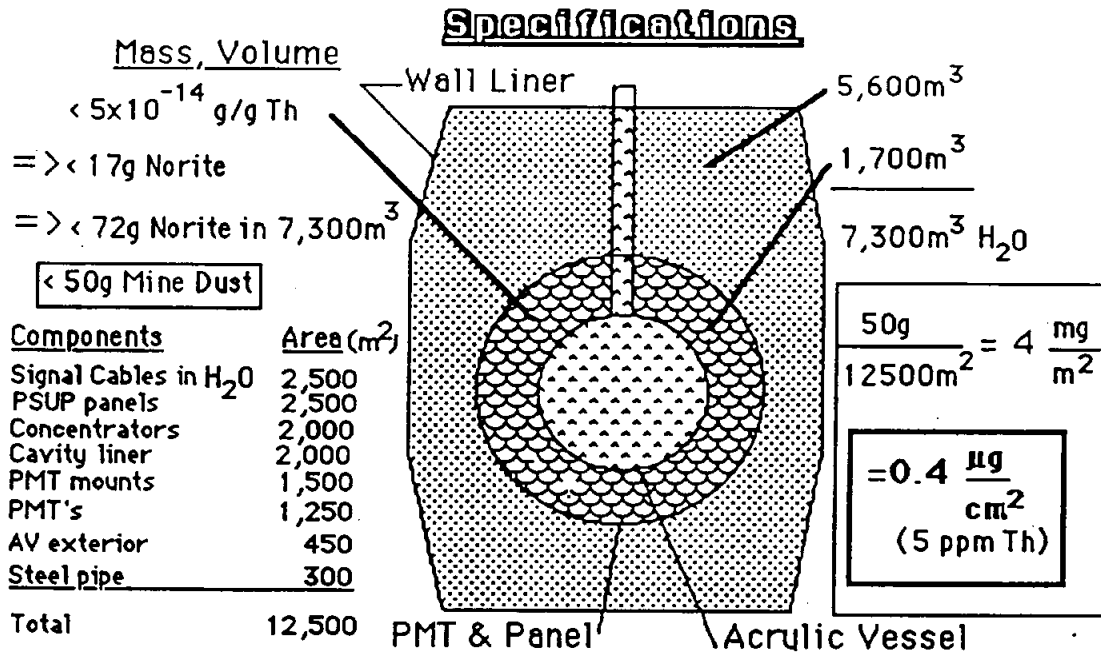

Figure 1. Surfaces and mine dust allowance in the observatory.

The $0.4 \mu\text{g}/\text{cm}^2$ dust level on all surfaces in the observatory is what we intend to accomplish. Therefore, this study is to ensure low dust level ($< 10 \mu\text{g}/\text{cm}^2$) is controllable, make samples with known amount of dust on different surfaces (2" x 3" witness plates), make both wipe and tape-lift tests on different surfaces, and analyze the results.

Two methods, X-ray fluorescence and optical counting, can be used for detecting and quantifying the amount of mine dust on flat surfaces. X-ray fluorescence is based on element detection, a method that yields mine-dust mass

measurement, whereas optical analysis is a particle counting technique that gives the number of mine-dust particles versus size. Two assumptions are made when applying these two methods: (i) that mine dust deposits uniformly on a flat surface and (ii) that its distribution fits a straight curve that corresponds to a power law distribution $N=k \cdot D^m$, where N is the number of particles per square centimeter, k is a constant, D is the diameter of the particle in microns, and m is the slope of the line.

Both methods can be combined to obtain the maximum diameter of dust particles on a flat surface. A flow diagram of the work related to this study is shown in Figure 2.

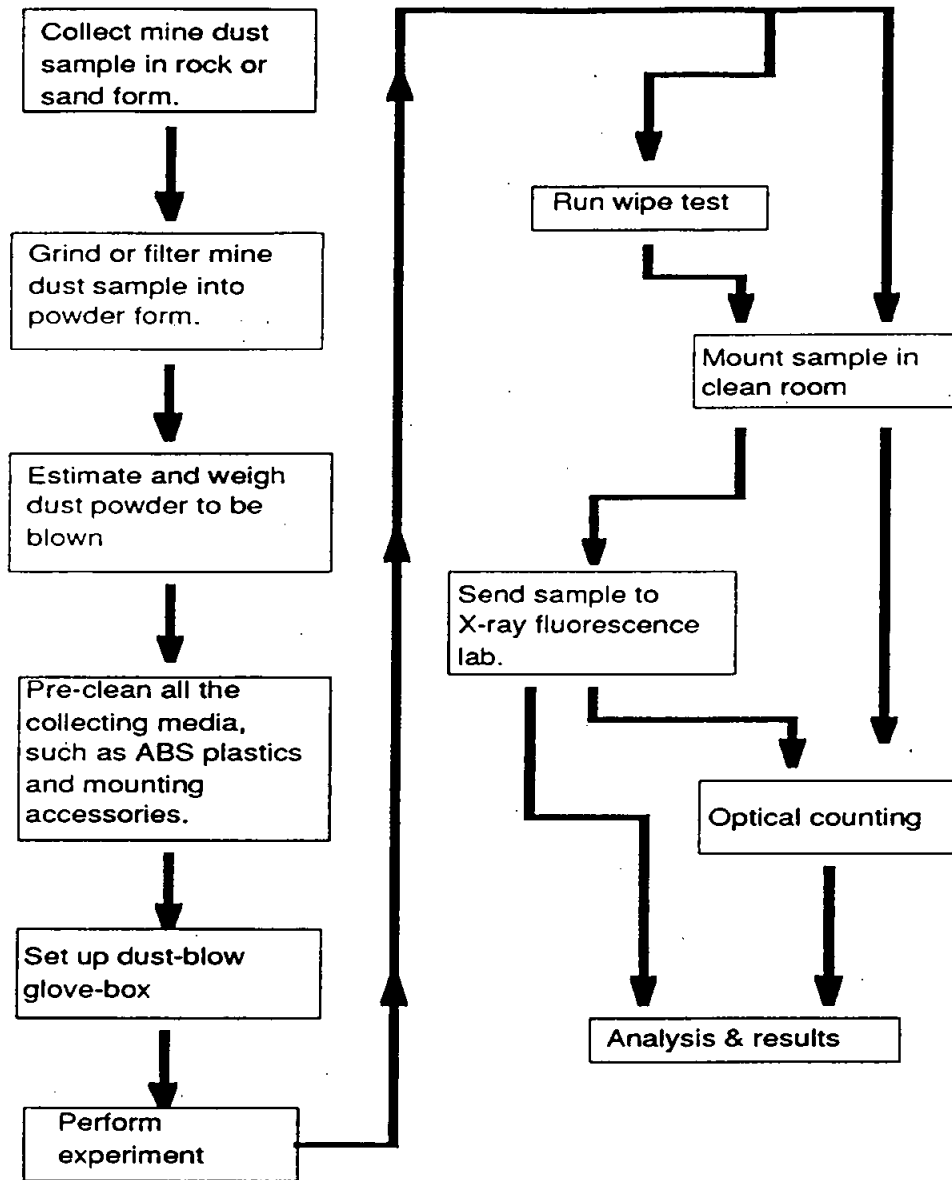

Figure 2. A flow diagram of this work.

2.0 Experimental System

The equipment used in this study includes a glove-box, a wipe-test device, an X-ray fluorescence system, and a binocular microscope. They will be described in detail.

2.1 Modified Glove-box

The glove-box is modified to be a blow dust set-up connected with a nitrogen gas tank. A picture and sketch of this set-up are shown in Figures 3 and 4.

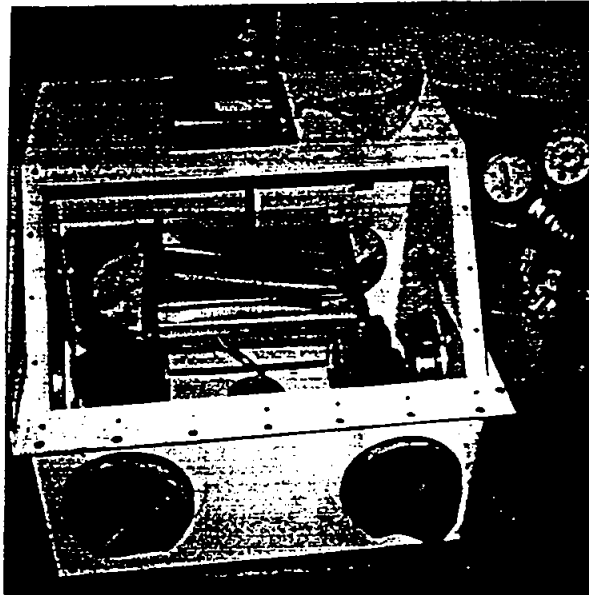

Figure 3. A picture of the modified glove-box.

The pair of goggles above the glove-box shows the relative size of the box. The volume of the box is about $95,426 \text{ cm}^3$, and the area of the platform sitting on the table is about 280 cm^2 . The pair of gloves is used to move things around inside the glove-box when it is sealed, to prevent dust entering from outside.

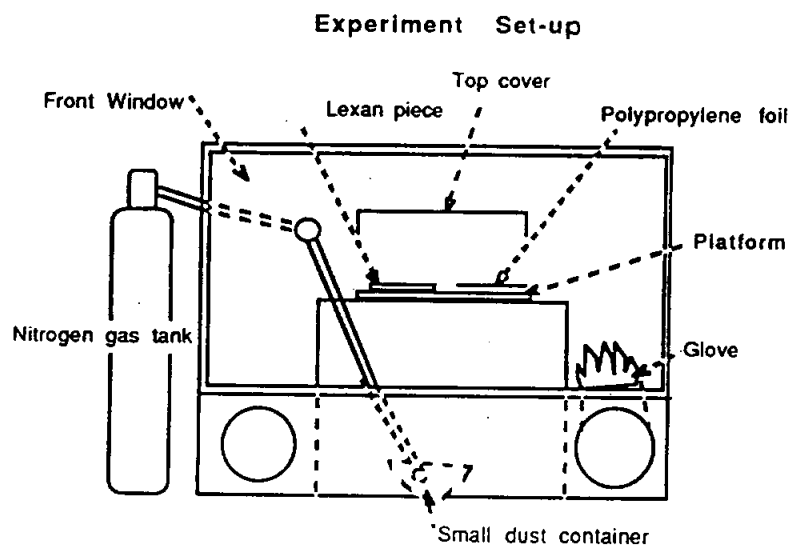

Figure 4. Schematic of the modified glove-box.

2.2 Wipe-test Device

A wipe-test cart (see Figure 5) is a small device that allows a constant force during a drag along the dusty surface to make a six-inch long, narrow dust-mark sample. The spring connected between the thin bar and the case maintains the constant force. The device has an eraser that is wrapped with the fabric tissue at its edge, and is inclined 30° from the surface. The device applies a constant force of approximate 1.3 lbs (600g) on the surface. The fabrics used are Tex wipe 309 and lens tissue.

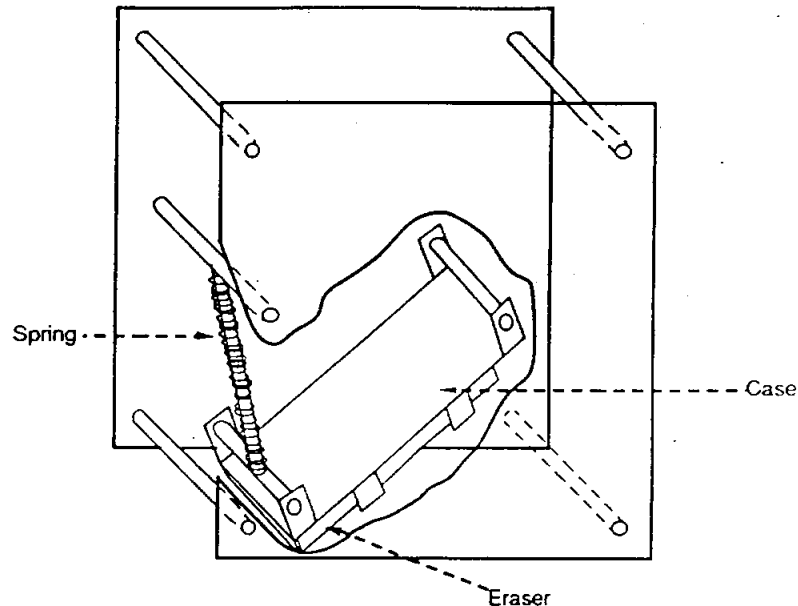

Figure 5. Preliminary wipe-test device.

2.3 X-ray Fluorescence

X-ray fluorescence is a quantitative method in which X-rays are used to measure the amounts of different elements in mine-dust samples. By knowing the percentage of different elements that the mine dust contains, we can determine the amount of mine dust in the samples.

Figure 6 shows a schematic of the X-ray fluorescence system. This system consists of an X-ray tube (# 6a) with a Molybdenum (element-Mo) anode for generating the X-rays and a Lithium-drifted Silicon Si(Li) detector (# 6b) for identifying the X-rays scattered by a mine-dust sample (# 6c). Once the detector absorbs the scattered X-rays from the sample, it passes this information into a spectrum analyzer. The spectrum analyzer (# 6d) translates this information from the detector into useful data by graphing the number of X-rays versus their energy. A computer (# 6e) stores the interpreted data from the spectrum analyzer on its hard disk and displays it on the monitor.

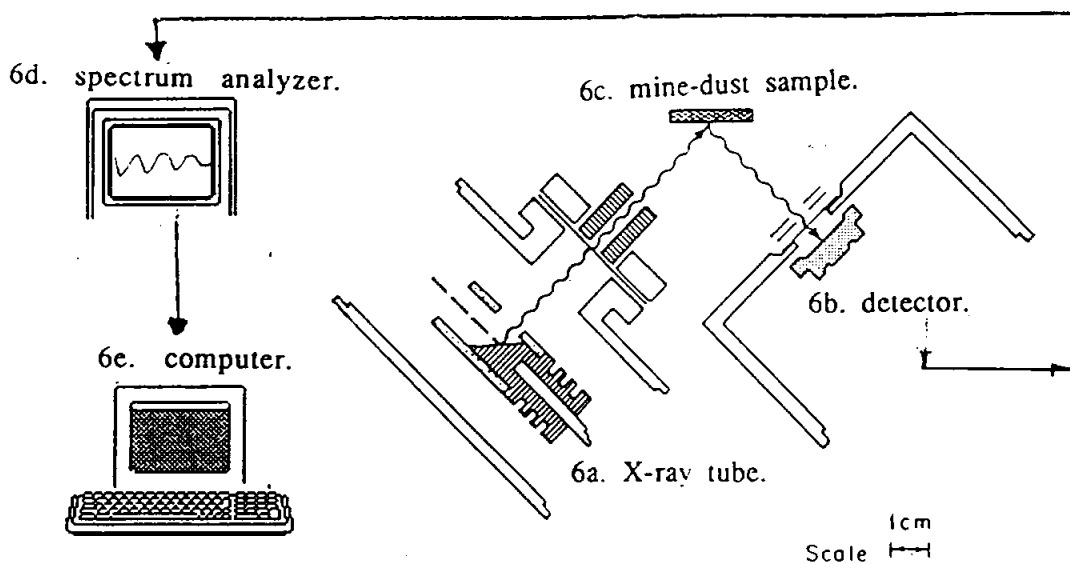

Figure 6. Schematic of an X-ray fluorescence analysis system.

This analysis is performed separately by an X-ray specialist, Bob Giauque.

2.4 Optical Counting

The mine-dust optical analysis is a particle-counting method that uses a binocular microscope to measure the number of particles as a function of their sizes.

The microscope is modified especially for particle counting and was used earlier to count nuclear tracks in photographic plates. This microscope has built-in illumination and three dials to read three different dimensions (X, Y, and Z) of the sample (see Figure 7): The depth dial controls the focus or Z dimension.

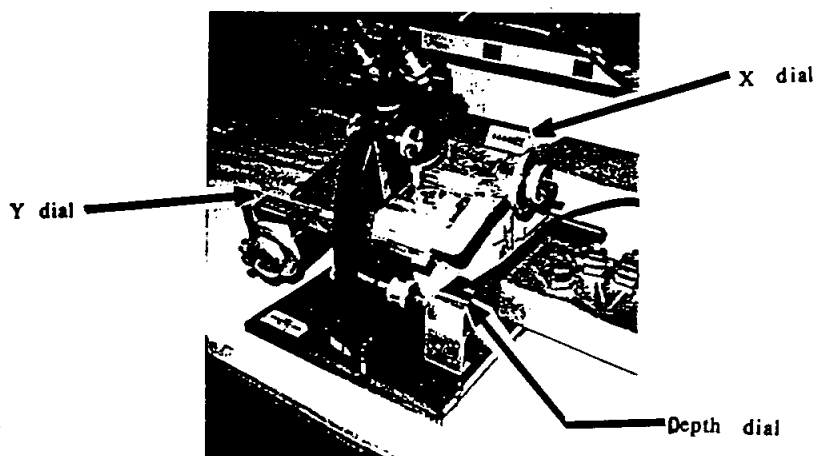

Figure 7. Picture of the microscope.

The microscope has two eye-pieces. One of the two eyepieces has a reticle (a lens mounted in the middle of the eyepiece) with a printed "Patterson globe and circle" guide mark that helps to locate the mine-dust particles for sizing and counting (see Figure 8). It is a standard rectangular box divided into nine equal size boxes (three columns and three rows) with two sets of different size circles (hollow and solid dots with numbers) printed above and below the box. These features are important for optical counting because they allow the user to follow a standard technique in optical counting. For example, by comparing a particle with the calibrated circles, its size can be determined.

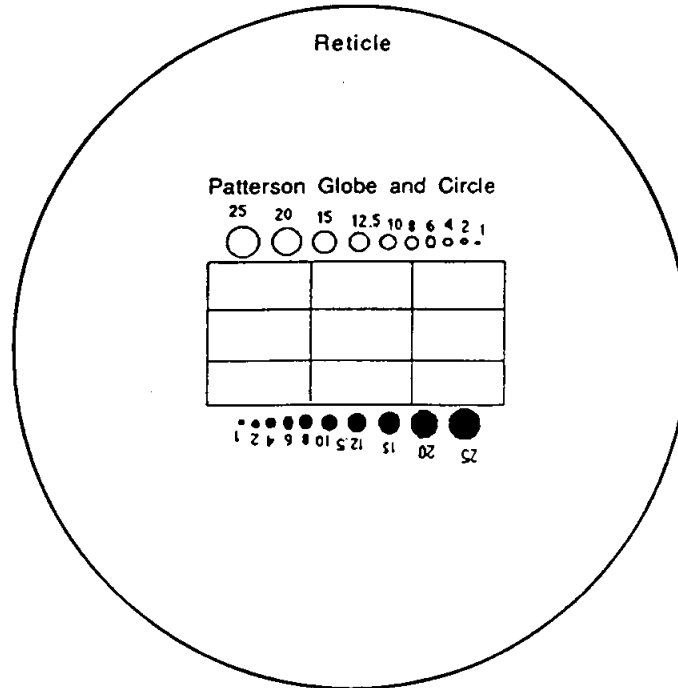

Figure 8. Microscope view for particle counting.

With 200X magnification, the numbers next to the circles represent the diameters of these circles in microns, and the big rectangular box is 0.245mm X 0.113mm.

3.0 Procedure and methods

3.1 Generating Samples

First of all, determine the required amount of dust for the desired mine-dust samples by calculating the glove-box volume, estimating the deposition rate, and considering losses in the air.

The dust collecting surface, such as ABS plastic and glass slides, are prepared and cleaned with regular hand-soap and deionized water in a cleanroom. Later on, they are dried and placed in desired order on the platform in the cleanroom, which is "Class 100". The cleanroom work station is a bench with HEPA (high-efficiency particulate air) filter to keep any foreign matter off the bench; therefore, preparing

samples on this bench prevents contamination of the samples. Figure 9 shows a picture of the clean bench.

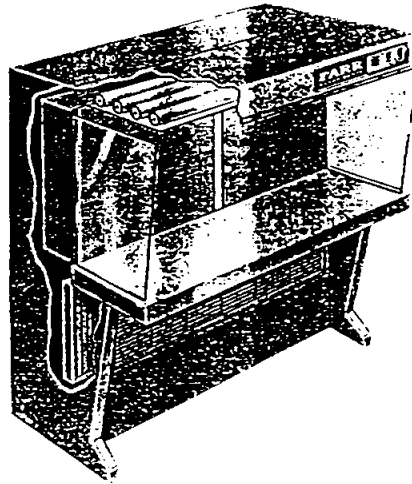

Figure 9. Typical clean bench showing the location of the HEPA filters and prefilters.
(Source: Philip R. Austin, Design & Operation of Clean Room, revised ed. Business New Publishing Co., p: 411.)

After finishing the dust-blow experiment in the glove box (outside the cleanroom), we transfer the platform (with cover) back to the cleanroom for tape-lift test, wipe test, and mounting. Tape-lift test is done by using Mylar and Acrylic tapes lightly pressing on any desired surface, from which dust particles will be picked up on the sticky side of the tapes. Wipe test is done by using the wipe-test device.

3.2 Sample Mounting

Each of these tapes (mentioned above) is put on a metal ring. Mylar tapes are placed into precleaned Petri dishes, but Acrylic tapes are mounted on the 2"x3" precleaned glass slides; Figure 10 shows this mounting technique.

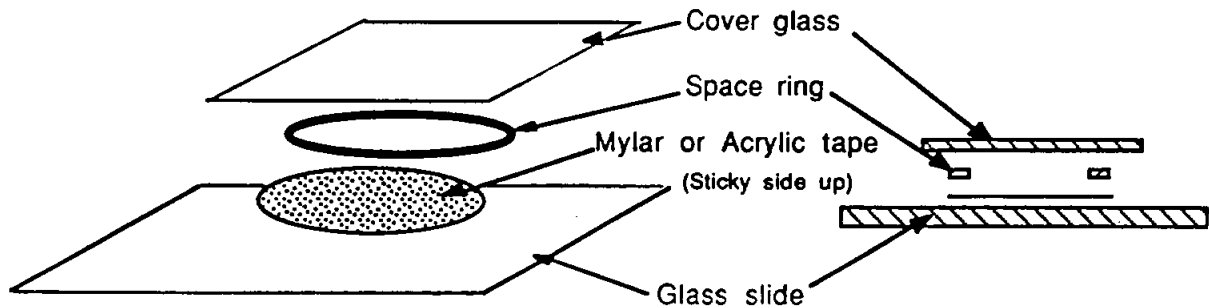

Figure 10. Mounting accessories and orientation.

After a wipe test has been done by using the wipe-test device, the fabric with a thin dust mark ($\sim 3/4$ inches long) is cut and put between two clean 1"x3" glass slides to prevent dirt from outside. Labelling is done on every sample.

The details of the above steps are listed below:

I. Preparation:

- 1) Clean mine-dust-collecting surfaces (such as 2"x3" glass slides and ABS plastic plates), plastic platforms, and a cover lid, with regular hand-soap and deionized water.
- 2) Transfer the above materials to cleanroom and dry them with cleanroom-cloth.
- 3) Place the media in desired order on the plastic platform and put the cover lid on before transfer them to the modified glove-box.
- 4) Vacuum the inner space of the glove-box.
- 5) Put measured mine dust (powder) into the small container.
- 6) Put a table on top of the container inside the glove-box.
- 7) Put another plastic platform on the table.
- 8) Put the 1st platform (with the media and cover lid on) on the 2nd platform.

II Dust Collection:

- 1) Seal the box by closing the front opening (window) with the plastic cover.
- 2) Use the pairs of gloves mounted on the box to remove the cover lid from platform into a plastic bag, which is inside the glove-box.
- 3) Set the Nitrogen gas to a 18 psi. pressure (gage reading).
- 4) Open the valve to the container and let the gas blow the dust for 15 minutes.
- 5) Fifteen minutes later, shut off the valve and let the media expose to the dust for 60 minutes.
- 6) Sixty minutes later, use the gloves to place the cover lid back on the platform.
- 7) Open the front window and take out the 1st platform with the media and lid on, to the cleanroom.

III Sample Collection in Cleanroom:

- 1) Tape-lift test.
- 2) Six-inch long wipe test.
- 3) Witness plates.
- 4) Polypropylene foils.

IV Sample Mounting:

- 1) Tapes (Acrylic and Mylar) on metal rings and glass slides.
- 2) Fabrics Tex-309 and lens's tissues between two 1"x3" glass slides.
- 3) 2"x3" ABS plastic and glass witness plates.
- 4) Polypropylene foils on plastic rings and glass slides.

After wipe tests, tape-lift tests, and mountings have been done, Mylar-tape samples are sent for X-ray analysis.

3.3 X-ray Fluorescence

For X-ray analysis, the Mylar-tape sample is located as shown (#6c) in Figure 6. A blank tape is always required as a background measurement for obtaining the actual amount of mine dust on other samples. When the X-ray system is turned on, radiation provided by an X-ray tube impinges upon the sample and covers three square centimeters at its center. The scattered X-rays are then measured by the detector [4]. The spectrum analyzer connected with the detector receives data (characteristic X-rays that are produced in the sample and reach the detector) and manipulates this data. The computer connected with the spectrum analyzer then sorts the result on its hard disk or sends it to the printer for hard copies as backup.

A typical X-ray result for a dust sample displayed on the computer monitor is shown in Figure 11. The X-ray method offers high sensitivity (about 0.15 microgram per cm^2) and it takes twenty minutes to obtain spectra that correspond to the elements from Ca through Sr [4]. The graph (Figure 11) shows that the sample contains mostly Iron, which is from the mine dust. The tape, as well as the mine-dust contains negligible amounts of other elements in the region from Ca through Sr. Since mine dust contains six percent Iron (Fe), dividing the detected Iron content by the number of 0.06 gives the amount of mine dust on the sample.

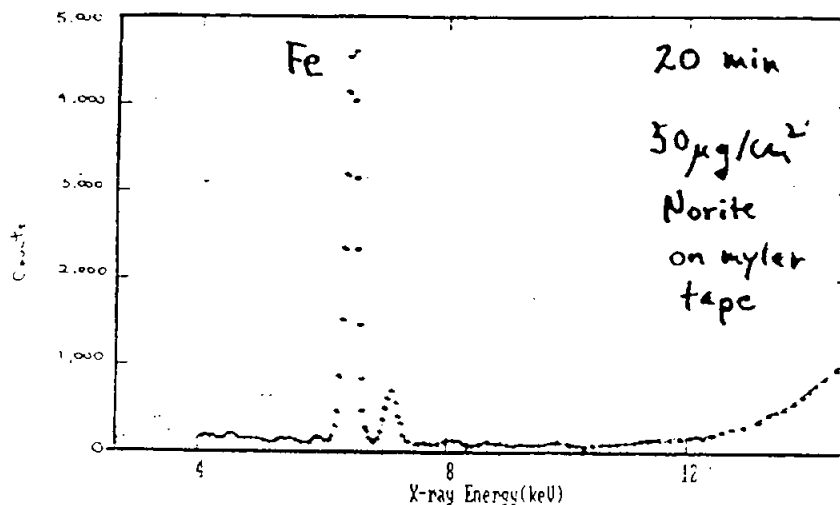

Figure 11. A sample of an X-ray analysis result.

3.4 Optical Counting

After the X-ray analysis is performed on the Mylar-tape samples, they are then mounted the same way as Acrylic-tape samples for optical counting. Before the mounted sample is placed under the microscope, the glass surface of the sample and the microscope lens are cleaned with cleaning fluid on "Kimwipe" paper and lens tissues. Two 10X oculars (eyepieces) and a 20X objective lens are used, so the total magnification will be 200X. After the cleaned, mounted sample has been set firmly on the microscope platform, the tester adjusts the depth control dial to locate the right level of particle's location. Then, Surveying the sample under microscope by quickly moving the X and Y dials provides the tester a general impression of the particle's distribution. Since the Mylar tape is not flat, depth changes as the location moves. The scale in the counting view of the microscope can be checked by selecting a particle, moving it to any desired position, and comparing the moving distance with the dial's readings. For example, if the magnification is 200X, the numbers next to the circles represent the diameters of these circles in microns; the dimension of the big rectangular box will be 0.245mm X 0.113mm.

A starting position for counting is set without looking into the microscope to avoid bias in the choice. The X dial is fixed, and only the Y dial is moved with a constant distance between each counting. Particles within the box and on the upper and left border of the box are counted. Particles are characterized by their diameters in ranges of $\geq 1\mu\text{m}$, $\geq 5\mu\text{m}$, $\geq 10\mu\text{m}$, $\geq 25\mu\text{m}$, and $\geq 50\mu\text{m}$ by comparing with the calibrated circles, so cumulative counting is performed. Each counting takes about an hour to cover 1mm^2 of each sample.

A graphical method is used for interpreting the result by the following equation:

$$N(\geq D) = k \cdot D^m$$

N is the number of particles greater or equal to D per cm^2 , k is a constant, D is the diameter of particle in microns, and m is the slope of the curve. A standard error analysis FORTRAN program "Method of Least Square" is applied to obtain the k and m values. Figure 12 shows a typical result in a graphical form. The square dots represent the actual data. The thick solid line represents the best-curve fitting result, and the two "dashed" lines represent the upper bound and lower bound errors. The cross dots represent the errors by having taken the square root of the actual data.

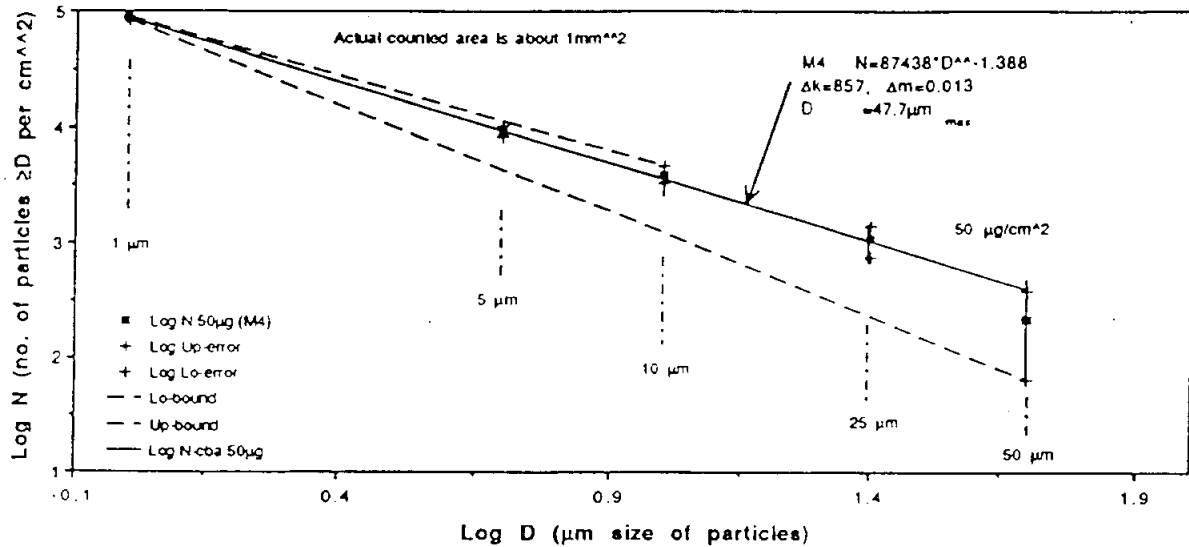

Figure 12. A typical optical counting result in graphical form.

3.5 Combination

Differentiating the equation, $N=kD^m$ with respect to D and integrating afterward, we can find the maximum particle size (D_{max}) for each sample because we know the mass per unit area of the sample (from the X-ray analysis). The calculation is shown below:

$$N(\geq D) = k \cdot D^m \left\{ \frac{1}{\text{cm}^2} \right\}$$

$$n(D) = -\frac{dN}{dD} = m \cdot k \cdot D^{m-1}$$

$$\frac{dM}{dD} \left\{ \frac{\text{gm}}{\text{cm}^2 \cdot \mu\text{m}} \right\} = -m \cdot k \cdot D^{m-1} \cdot \frac{\pi \cdot D^3}{6} \cdot \rho \quad (\text{volume}) \quad (\text{density})$$

$$\text{For Norite dust } \rho = 2.85 \cdot 10^{-12} \left\{ \frac{\text{gm}}{\mu\text{m}^3} \right\}$$

$$M \left\{ \frac{\text{gm}}{\text{cm}^2} \right\} = \int_{D=0}^{D_{\max}} -m \cdot k \cdot \frac{\Pi}{6} \cdot \rho \cdot D^{m+2} \cdot dD$$

$$= -m \cdot k \cdot \frac{\Pi}{6} \cdot \rho \cdot \frac{D_{\max}^{m+3}}{m+3}$$

$$D_{\max} \{ \mu\text{m} \} = \sqrt[m+3]{\frac{M \cdot (m+3)}{-m \cdot k \cdot \frac{\Pi}{6} \cdot \rho}}$$

Where

M is mass per square centimeter.

m is the slope of the line, unitless.

k is a constant.

ρ is Norite density.

4.0 Results:

We present the results in both tabular and graphical forms, in a total of four tables and ten graphs.

Table 1 and Figures 13, 14, 15, and 16 show the results for Mylar tape onto which ground Norite had been blown, polypropylene foils with dust deposited on them in the mine, and samples of dust collected on air filters in the mine.

Samples were prepared in different ways. Samples M2 to M4 were made by having mine dust adjacent to tapes and blown onto the tapes. Polypropylene-foil samples (PL-1, PH-1, B2, and B3) were made by exposing these foils to air in the mine. Air-filter samples were made by sucking air through the filters at two different locations in the mine. We would not expect the air filter sample distributions (m value) and maximum particle size to be the same as other samples. We note that the samples prepared with mechanically ground Norite have values of m and D_{\max} within the range spanned by samples prepared with dust taken from the mine.

Sample Source	Sample Prepared	Sample Label	Scanning Area	Scanning Particle Size Greater than 1 mm Diameter				X-Ray Fluorescence		Maximum Particle size D_{max} (μm)
				Optical Counting Result				Fe (ng/cm ²)	Mine Dust ($\mu g/cm^2$)	
				N (number of particles $\geq D$ per cm ²) = $K \cdot D^m$						
K	$\pm \Delta K$	m	$\pm \Delta m$							
Norite, ground into powder and blown onto Mylar Tapes	Light Blow	M2	1 mm ²	19303	1443	-1.867	0.105	74 \pm 6	1.2 \pm 0.1	17.3
	Medium Blow	M3		38142	1435	-1.683	0.052	1300 \pm 100	22 \pm 2	76.5
	Hard Blow	M4		87438	857	-1.388	0.013	3400 \pm 200	57 \pm 3	47.7
Polypropylene Foils Placed on Body Walking along the Mine	On Leg	PL-1	1.1 mm ²	256805	4775	-1.547	0.028	$1/2(6740 \pm 30)$	56.2 \pm 0.3	29.7
	On Helmet	PH-1	1.15 mm ²	73760	1253	-1.674	0.021	$1/2(2040 \pm 20)$	17.0 \pm 0.2	37.5
Polypropylene Foils Placed on Different Location at the Mine	Settled Dust (SD), Lab at 4600 ft. below Ground	B2	1.1 mm ²	20205	1353	-2.332	0.100	$1/2(40 \pm 5)$	0.33 \pm 0.04	5.5
	(SD), Electronic Corridor at 6800 ft. below GD	B3	1.1 mm ²	391237	5894	-1.559	0.022	$1/2(16600 \pm 100)$	138 \pm 2	42.0
Filters Collect Dust at Different Location at the Mine	Wash Station, 6800 ft. below GD, 330 $\mu g/m^3$	F1	3.7 mm ²	242923	9348	-2.747	0.054	1790 \pm 20	29.8 \pm 0.2	2985
	Outside Lab, 4600 ft. below GD, 167 $\mu g/m^3$	F2	21 mm ²	578	50	-1.001	0.071	70 \pm 6	1.2 \pm 0.1	52.8

Table 1. Optical counting and X-ray fluorescence results of mine-dust samples collected by E.D. Hallman and R.G. Stokstad at the mine.

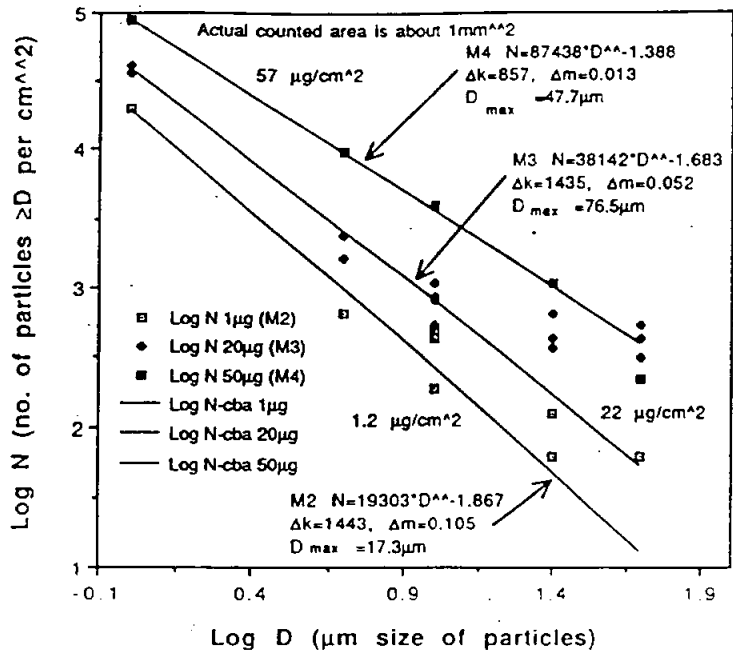

Figure 13. Plot of number vs. size distribution for ground Norite samples.

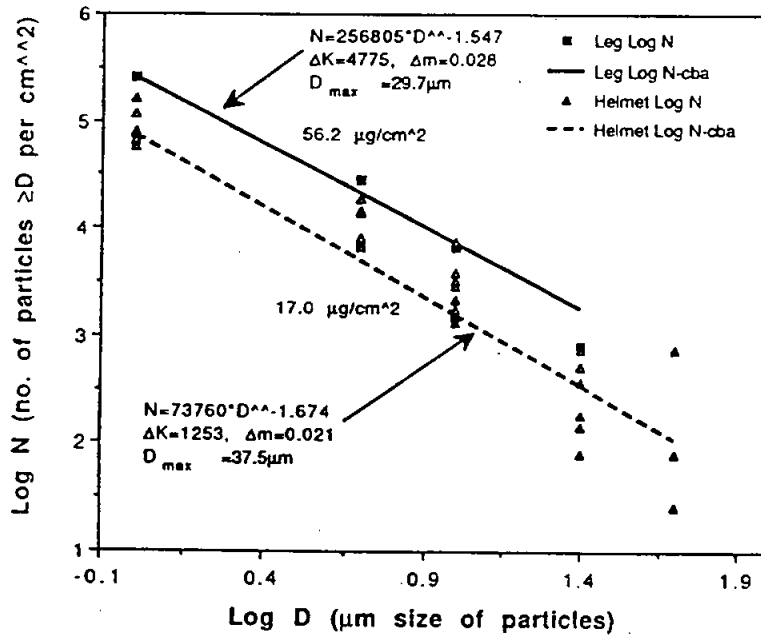

Figure 14. Plot of samples with mine dust deposited on polypropylene foils mounted on leg and helmet during the underground tour on 6/91.

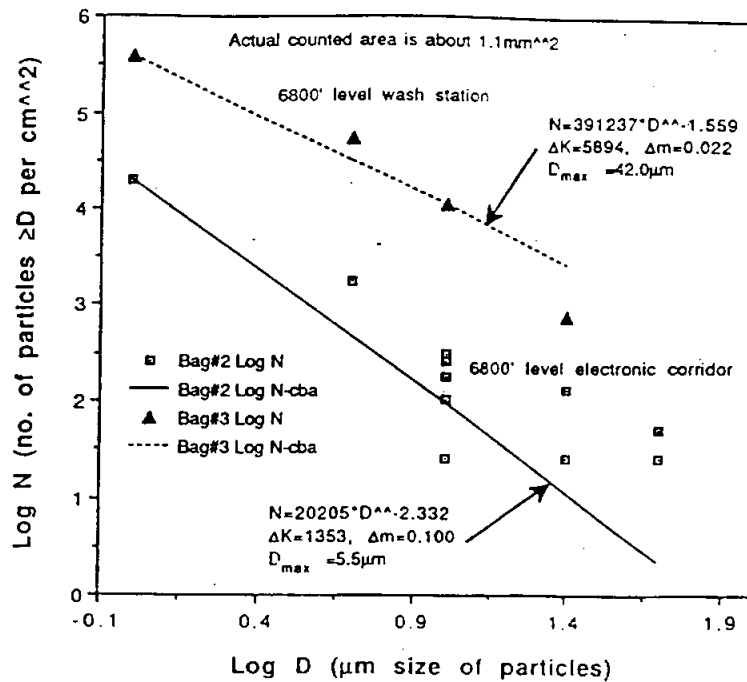

Figure 15. Plot of samples with mine dust deposited on polypropylene foils.

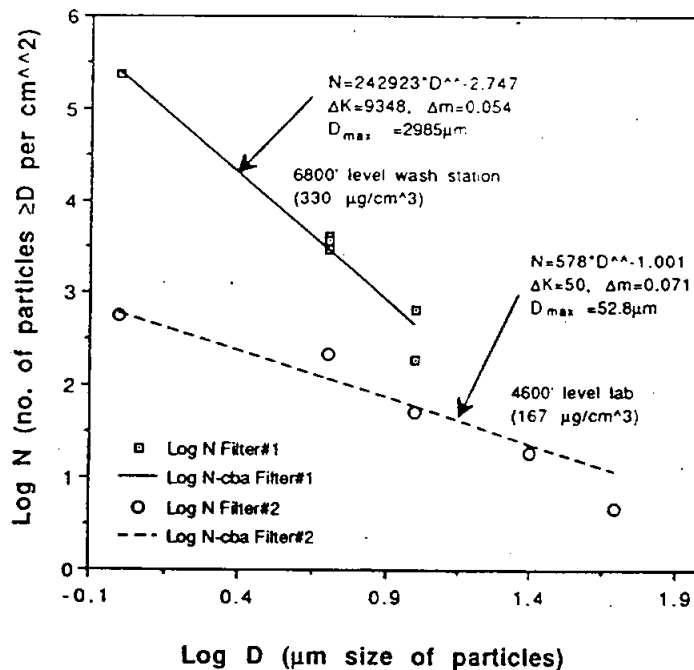

Figure 16. Plot of samples with mine dust deposited on air filters.

The next two sets of results were obtained in two experiments (on 10/10/91 and on 10/31/91) using the modified glove-box to deposit mine dust on a variety of surfaces -- ABS plastic, glass slide, Acrylic tape, and Mylar tape. The purpose was to correlate and compare the mass deposited, particle number and size distributions on different surfaces exposed to the same source of dust. Background or control experiments on clean surfaces were also made. From these experiments we wanted to evaluate the different methods for measuring dust on surfaces.

Table 2 and Figures 17 and 18 show the results of all the samples prepared in a blow done on 10/10/91, using the modified glove-box.

Sample Source	Optical Counting Scanning Particle Size Greater than 5 μm Diameter							X-Ray Fluorescence				Maximum Particle Size D_{max} (μm)	
	Sample Preparation (Done in Cleanroom)	Sample Label	Scanning Area	Counting Result N (number of particles $\geq D$ per cm^2) = $K \cdot D^m$				Sample Preparation (Done in Cleanroom)	Sample Label	Fe (ng/cm^2)	Dust ($\mu\text{g}/\text{cm}^2$)		
				K	$\pm\Delta K$	m	$\pm\Delta m$						
Blow Ground Norite-Dust in Glove Box (see experiment Set-up)	Clean Glass Slide	OP-1	29mm ²	1655	22	-1.571	0.007						
	Dusty Glass Slide	OP-2		46398	12492	-2.275	0.151						
	Clean Glass Slide after Tape Lift	OP-3		1901	1186	-1.667	0.330						
	Dusty Glass Slide after Tape Lift	OP-4		1581	1031	-1.707	0.339						
	Clean Acrylic Tape (Background)	OP-5		5672	-----	-2.737	-----	Clean Mylar Tape (Background)	XR-1	-----	-----		
	Acrylic Tape Sticky Side up (Dusty)	OP-6		12677	3371	-1.845	0.141	Mylar Tape Sticky Side up (Dusty)	XR-2	66 \pm 6	1.1 \pm 0.1	22.5	
	Acrylic Tape Lift on Clean ABS Plastics	OP-7		1501	817	-1.501	0.281	Mylar Tape Lift on Clean Glass Slide	XR-7	9 \pm 5	0.15 \pm 0.08	16.5	
	Acrylic Tape Lift on Dusty ABS Plastics	OP-8		2658	854	-1.392	0.158	Mylar Tape Lift on Dusty Glass Slide	XR-8	99 \pm 6	1.7 \pm 0.1	47.4	
	Acrylic Tape Lift on Clean Glass Slide	OP-9		1229	519	-1.298	0.204	Mylar Tape Lift on Clean ABS Plastics	XR-3	3 \pm 5	0.05 \pm 0.08	8.2	
	Acrylic Tape Lift on Dusty Glass Slide	OP-10		11004	2381	-1.682	0.111	Mylar Tape Lift on Dusty ABS Plastics	XR-4	54 \pm 6	0.9 \pm 0.1	17.3	
	Acrylic Tape Lift on ABS Plastics underneath Polypropylene foil	OP-11		3344	1268	-1.683	0.194	Mylar Tape Lift on ABS Plastics underneath Polypropylene Foil	XR-9	2 \pm 5	0.03 \pm 0.08	3.2	
	Acrylic Tape Lift on ABS Plastics underneath Glass Slide	OP-12		5971	2175	-1.840	0.192	Mylar Tape Lift on ABS Plastics Underneath Glass Slide	XR-10	1 \pm 5	0.02 \pm 0.08	42.0	
						Dusty Polypropylene Foil	XR-6	¹ / ₂ (129 \pm 5)	1.08 \pm 0.05				

Table 2. Optical counting and X-ray fluorescence results for the dust-blow experiment done on 10/10/91.

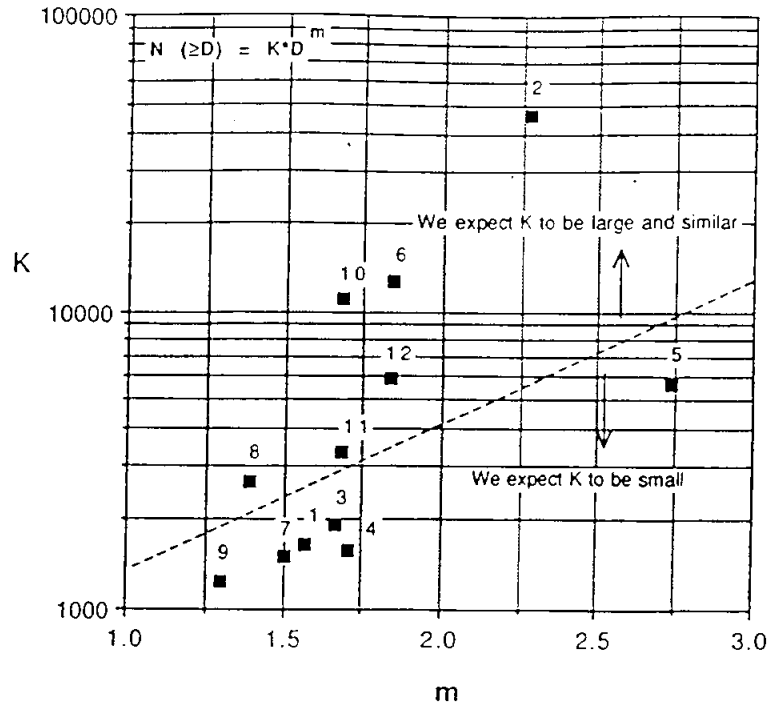

Figure 17. Mine dust (number-size distribution) on different surfaces measured by optical counting of tape lift and witness plates. (10/10/91)

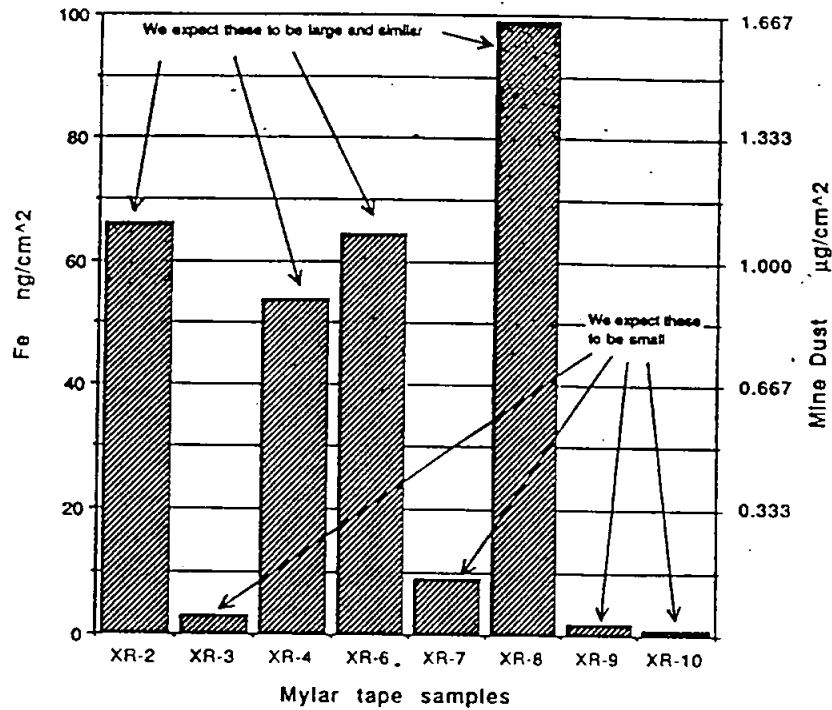

Figure 18. Mine dust ($\mu\text{g}/\text{cm}^2$) on different surfaces measured by X-ray analysis of tape lift and witness plates. (10/10/91)

Table 3 and Figures 19 and 20 show the results of all the samples prepared in a blow done on 10/31/91. With more samples, the result gives better statistical data to support the study.

Sample Source	Optical Counting Scanning Particle Size Greater than 5 μm Diameter						X-Ray Fluorescence				Maximum Particle Size D_{max} (μm)	
	Sample Preparation (Done in Cleanroom)	Sample Label	Scanning Area	Counting Result N (number of particles $\geq D$ per cm^2) = $K \cdot D^m$				Sample Preparation (Done in Cleanroom)	Sample Label	Fe (ng/cm^2)		Dust ($\mu\text{g}/\text{cm}^2$)
				K	$\pm\Delta K$	m	$\pm\Delta m$					
Blow Ground Norite Dust in Glove Box (see experiment Set-up)	Clean Glass Slide	OP103191-1	29mm ²	8475	-----	-3.087	-----					
	Dusty Glass Slide	OP103191-2		20761	4300	-1.963	0.111					
	Acrylic Tape Sticky Side up (Dusty)	OP103191-3		5717	1524	-1.567	0.135	Mylar Tape Sticky Side up (Dusty)	XR103191-3	133 \pm 6	2.2 \pm 0.10	45.3
	Acrylic Tape Lift on Clean ABS Plastics (Smooth surface)	OP103191-4		887	510	-1.394	0.283	Mylar Tape Lift on Clean ABS Plastics (Smooth Surface)	XR103191-4	6 \pm 5	0.10 \pm 0.08	16.1
	Acrylic Tape Lift on Dusty ABS Plastics (Smooth surface)	OP103191-5		21107	1018	-2.065	0.026	Mylar Tape Lift on Dusty ABS Plastics (Smooth Surface)	XR103191-5	150 \pm 7	2.5 \pm 0.1	46.1
	Acrylic Tape Lift on Clean Glass Strip	OP103191-8		521	83	-1.368	0.079	Mylar Tape Lift on Clean Glass Strip	XR103191-6	-4 \pm 5	-0.07 \pm 0.08	-----
	Acrylic Tape Lift on Dusty Glass Strip	OP103191-9		11250	2810	-1.712	0.130	Mylar Tape Lift on Dusty Glass Strip	XR103191-9	55 \pm 6	0.9 \pm 0.1	17.6
								Dusty Polypropylene Foil	XR103191-10	1/2(195 \pm 6)	1.63 \pm 0.05	-----

Table 3. Optical counting and X-ray fluorescence results for the dust-blow experiment done on 10/31/91.

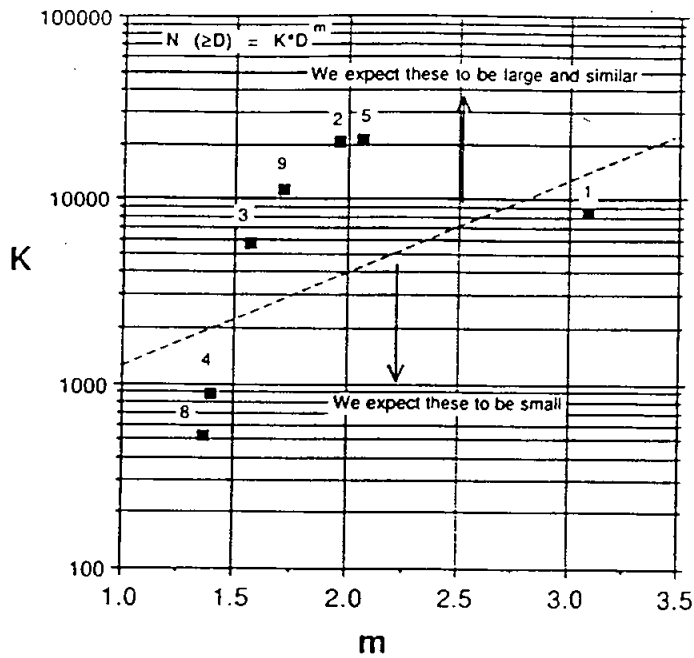

Figure 19. Mine dust (number-size distribution) on different surfaces measured by optical counting of tape lift and witness plates. (10/31/91)

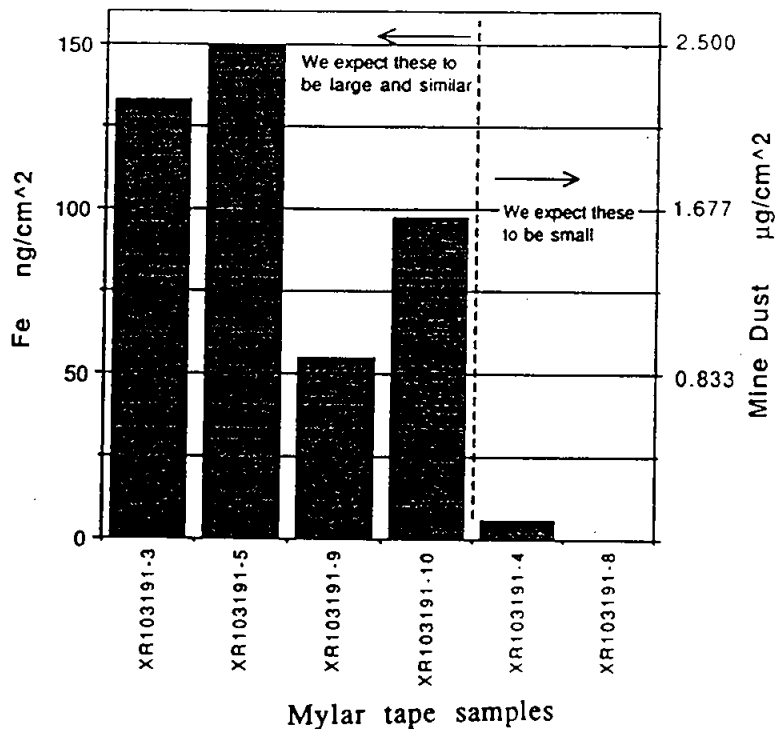

Figure 20. Mine dust ($\mu\text{g}/\text{cm}^2$) on different surfaces measured by X-ray analysis of tape lift and witness plates. (10/31/91)

The above results show that X-ray fluorescence gives better results for mass detection than optical analysis.

According to the finding that different materials have different k and m values, All Mylar-tape samples are recounted with the same systematic way to check if these values will be consistent with their mine-dust level. Table 4 and Figures 21 and 22 show the result.

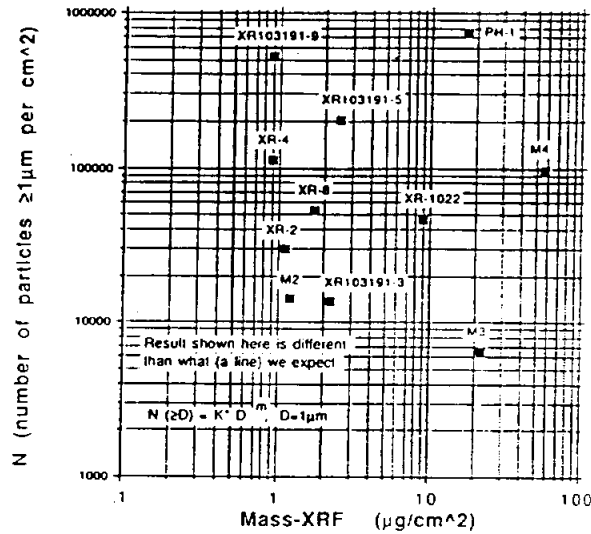

Figure 21. Comparison of total number of particles/cm² with mass/cm² (with dust particle diameter $D \geq 1\mu m$).

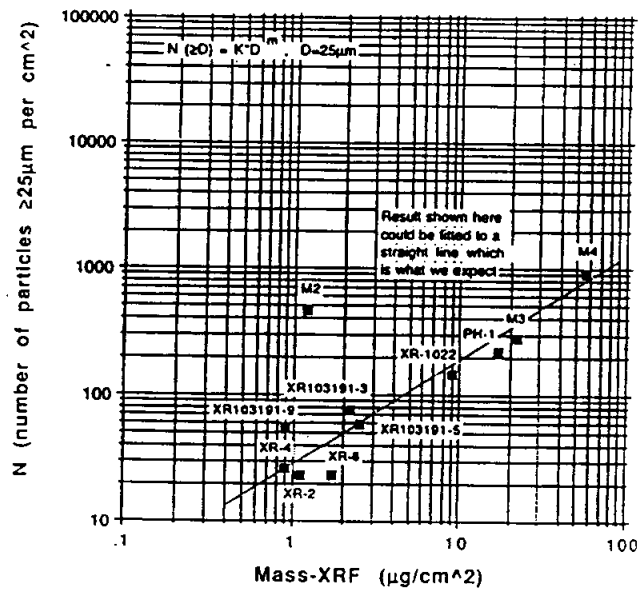

Figure 22. Comparison of total number of particles/cm² with mass/cm² (with dust particle diameter $D \geq 25\mu m$).

Sample Source	Optical Counting Scanning Particle Size Greater than 5 μm Diameter							X-Ray Fluorescence		Maximum Particle Size D_{max} (μm)
	Sample Preparation (Done in Cleanroom)	Sample Label	Scanning Area	Counting Result N (number of particles $\geq D$ per cm^2) = $K \cdot D^m$				Fe (ng/cm^2)	Dust ($\mu\text{g}/\text{cm}^2$)	
				K	$\pm\Delta K$	m	$\pm\Delta m$			
All Mylar Tapes	Blow Dust on Mylar Tape Directly Light Blow	M2	29 mm^2	14322	3002	-1.707	0.109	74 \pm 6	1.2 \pm 0.1	18.2
	Blow Dust on Mylar Tape Directly Medium Blow	M3		6549	823	-0.979	0.057	1300 \pm 100	22 \pm 2	65.2
	Blow Dust on Mylar Tape Directly Hard Blow	M4		97823	5069	-1.458	0.026	3400 \pm 200	57 \pm 3	49.7
	Mylar Tape Sticky Side up (Dusty)	XR-2		29819	8495	-2.223	0.157	66 \pm 6	1.1 \pm 0.1	16.0
	Mylar Tape Lift on Dusty ABS Plastics	XR-4		112665	21343	-2.599	0.108	54 \pm 6	0.9 \pm 0.1	0.6
	Mylar Tape Lift on Dusty Glass Slide	XR-8		53067	12681	-2.400	0.133	99 \pm 6	1.7 \pm 0.1	16.5
	Mylar Tape Sticky Side up (Dusty)	XR-1022		46120	6137	-1.788	0.070	546 \pm 22	9.1 \pm 0.4	40.8
	Mylar Tape Sticky Side up (Dusty)	XR103191-3		13658	2569	-1.616	0.096	133 \pm 6	2.2 \pm 0.10	26.3
	Mylar Tape Lift on Dusty ABS Plastics (Smooth Surface)	XR103191-5		204123	33472	-2.534	0.093	150 \pm 7	2.5 \pm 0.1	2.4
	Mylar Tape Lift on Dusty Glass Strip	XR103191-9		523776	58376	-2.853	0.064	55 \pm 6	0.9 \pm 0.1	4.5 $\times 10^{-9}$
Polypropylene Foil	Polypropylene Foils Placed on Helmet to Receive Dust at Mine	PH-1	748652	59873	-2.527	0.045	1/2(2040 \pm 20)	17.0 \pm 0.2	9.1	

Table 4. Recounting of selected Mylar-tape and polypropylene samples with X-ray fluorescence results.

Figures 16 and 20 each show that the X-ray analysis indicated the same amount of mass (to within a factor of two) was deposited on the four different surfaces exposed to the same source of dust. This is what we would expect if the dust in the air in the glove box was reasonably uniform. On the other hand, when we optically counted the same sets of samples, we found that the values of k and m varied considerably. This may reflect the very small areas which are sampled by optical counting. Also, we have no way of knowing *a priori* what value of D_{max} to use in integrating the number-size distribution to obtain the mass.

Figures 21 and 22 show what happens if we try to correlate the mass (measured by XRF) with the total number of particles/cm² on a sample. Figure 21 shows that there is no obvious correlation between the mass and the total number of particles with diameter \geq one micron. Figure 22 shows that there is a reasonable correlation between mass and the total number of particles/cm² with diameters $\geq 25 \mu\text{m}$. Since the distributions have different slopes ($-2.8 \leq m \leq -1$) and the mass is concentrated in the larger particles ($M \propto D^3$), the mass/cm² correlates better with the number of particles/cm² with larger diameters ($D \geq 25 \mu\text{m}$). This result holds, however, only for number-size distribution with exponents $m \geq -3$. If $m < -3$, the mass would be concentrated in the small particles, and we would need to determine a D_{min} instead of a D_{max} to integrate the number-size distribution.

5.0 Conclusions and Further Observations

Given the above results, we conclude that X-ray analysis is more reliable than optical counting for determining the amount (mass) of mine dust on a surface. However, optical counting is still useful because it is a tool for graphical interpretation and research.

In a separate series of experiments, we determined that the Mylar tape we use has about 97 ± 4^3 % efficiency in picking up dust on the glass surface and 99 ± 2^1 % on the ABS plastic surface.

Properties of the Mylar and Acrylic tapes are provided in the following table for reference.

Tape	Thickness (mil)	Weight (mg/cm ²)	Fe content (ng/cm ²)	Fe content (ppm)
Mylar	2.4 (65 μm)	7.1	30	4
Acrylic	(125 μm)	12	60	8

Table 5. Properties of the Mylar and Acrylic tapes.

From our dust-blow samples, we found that dust deposits non-uniformly on our prepared sample surfaces, especially on the Acrylic plastics. This non-uniform deposition can have an effect on the results if only small areas are examined.

The existing glove box is small for producing calibrated samples. Therefore, a new, bigger glove-box has been modified for uses. With bigger capacity, more samples can be made in one blow. Finally, four sets of samples combined with wipe fabrics, Mylar tapes, witness plates, and tape-lift tapes are made. Their mine dust levels are from 0.6 to 13.5 $\mu\text{g}/\text{cm}^2$. Display holders have been made to store all these samples. Optical counting on these samples (only Acrylic-plastic samples) has been done, and the results have been discussed and recorded in the log book.

Stainless steel, which has a semi-smooth surface, is difficult to study with the methods used previously, because its material comes loose in the tape-lift test; besides, it is hard to recognize if dust is on the surface or not. Nevertheless, stainless steel samples will be made but are limited to wipe-test samples only.

6.0 Future Work

We have developed methods for monitoring mine dust on flat surfaces but not on rough surfaces. Therefore, we will develop technique for monitoring dust on rough surfaces. A preliminary approach is to spray fluid on the rough surface, then collect this fluid, and finally filter it for analysis.

References

- [1] Philip R. Austin, Design & Operation of Clean Room, revised ed. Business New Publishing Co., pp. 8-14.
- [2] E.D. Hallman & R.G. Stokstad, "Establishing a cleanliness program and specifications for the Sudbury Neutrino Observatory," Report SNO-STR-91-009, p9, July 26, 1991.
- [3] Robert D. Giauque et al., "Determination of trace elements in light element matrices by X-ray fluorescence spectrometry with incoherent scattered radiation as an internal standard," Analytical Chemistry, pp. 511-516, April 1979.
- [4] Robert D. Giauque et al., "Trace element determination with semiconductor detector X-ray spectrometers," Analytical Chemistry, vol 45, p. 671, April 1973.
- [5] "Standard methods for microscopical sizing and counting particles from aerospace fluids on membrane filters," ASTM Standard F 312-69, 1980, pp. 437-439.
- [6] "Standard methods for sizing and counting airborne particulate contamination in clean rooms and other dust-controlled areas Designed for Electronic and similar Applications," ASTM Standard F 25-68, 1988, pp. 16-21.